

# Round Red LED Lamp (3mm)

## OVLAS6CB8

- 65° viewing angle
- Diffused lens for uniform light output
- Available on tape or reel
- Red color (628nm)

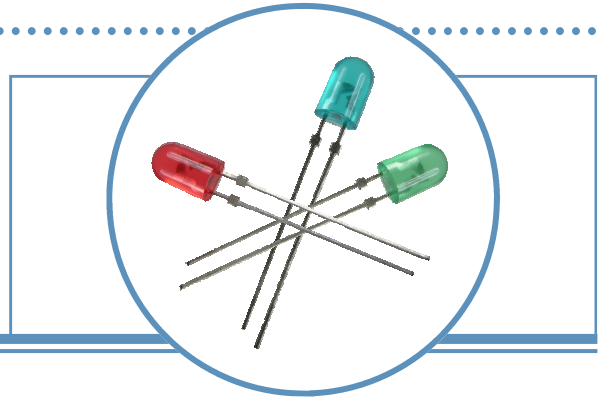

The OVLAS6CB8 is designed for wide-angle, uniform light output. The industry standard leads have a stand-off making this package ideal for PC board process assembly.

## Applications

- Indicators for Medical, Industrial, Consumer, and Office Equipment
- Indicators for White Goods and Home Appliances
- Interior and Exterior Architectural and Accent Lighting
- Signs and Digital Information Displays, Video Screen Non-color and RGB Presentation
- Automotive Backlighting and Indicators

Part Number	Material	Emitted Color	Intensity Typ. mcd	Lens Color
OVLAS6CB8	AllnGaP	Red	1100	Water Clear

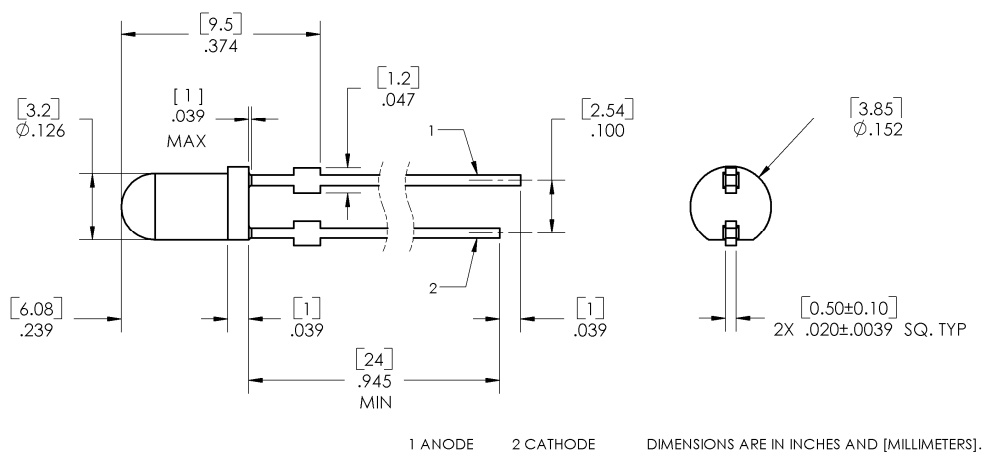

OPTEK reserves the right to make changes at any time in order to improve design and to supply the best product possible.

# Round Red LED Lamp (3mm)

## OVLAS6CB8



### Absolute Maximum Ratings

T<sub>A</sub> = 25°C unless otherwise noted

Storage Temperature Range	-40 ~ +100 °C
Operating Temperature Range	-40 ~ +95 °C
Reverse Voltage	5 V
Continuous Forward Current	50 mA
Peak Forward Current (10% Duty Cycle, 1KHz)	200 mA
Power Dissipation	130 mW
Lead Soldering Temperature (3mm from the base of the epoxy bulb) <sup>1</sup>	260 °C

Note:

1. Solder time less than 3 seconds at temperature extreme.

### Electrical Characteristics

T<sub>A</sub> = 25°C unless otherwise noted

SYMBOL	PARAMETER	MIN	TYP	MAX	UNITS	CONDITIONS
I <sub>v</sub>	Luminous Intensity	550	1100	----	mcd	I <sub>F</sub> = 20mA
V <sub>F</sub>	Forward Voltage	----	2.3	2.6	V	I <sub>F</sub> = 20mA
I <sub>R</sub>	Reverse Current	----	----	100	μA	V <sub>R</sub> = 5V
λ <sub>D</sub>	Dominant Wavelength	620	628	635	nm	I <sub>F</sub> = 20mA
2Θ <sub>1/2</sub> H-H	50% Power Angle	----	65	----	deg	I <sub>F</sub> = 20mA

### Standard Bins (I<sub>F</sub> = 20mA)

Lamps are sorted to luminous intensity (I<sub>v</sub>) and dominant wavelength (λ<sub>D</sub>) bins shown. Orders for OVLAS6CB8 may be filled with any or all bins contained as below.

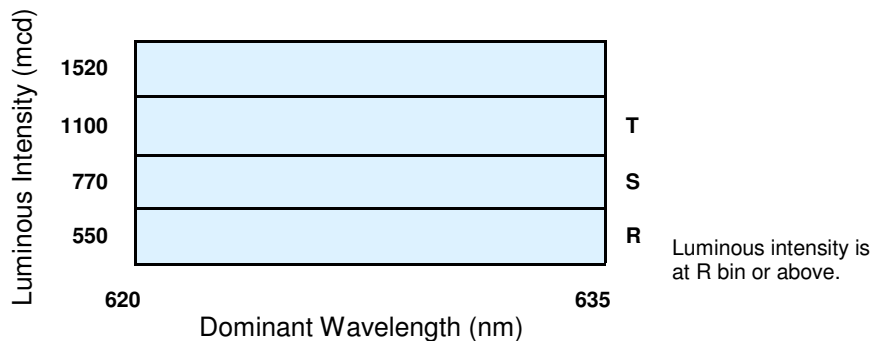

#### Important Notes:

1. All ranks will be included per delivery, rank ratio will be based on the chip distribution.
2. To designate luminous intensity ranks, please contact OPTEK.
3. Pb content <1000PPM.

Typical Electro-Optical Characteristics Curves

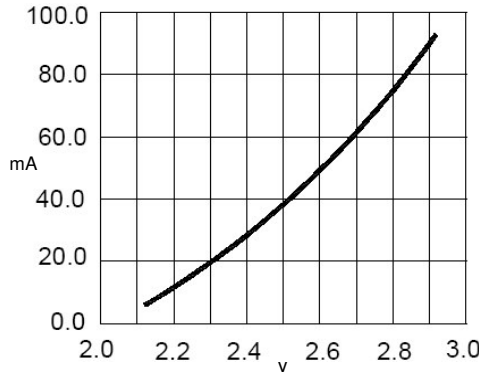

Forward Current vs. Forward Voltage

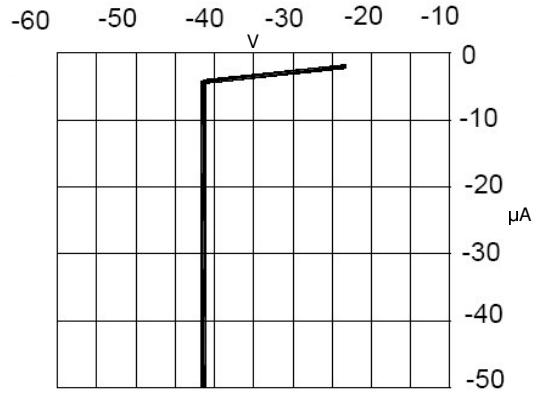

Reverse Current vs. Reverse Voltage

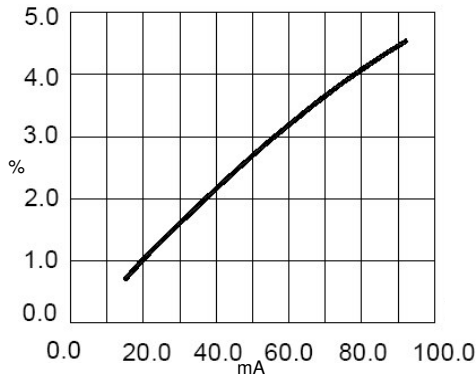

Relative Luminous Intensity vs. Forward Current

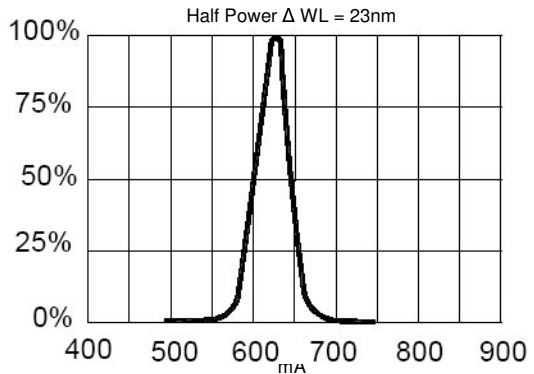

Relative Luminous Intensity vs. Wavelength

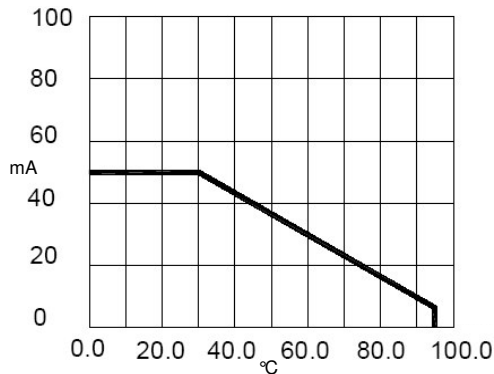

Maximum Forward DC Current vs. Ambient Temperature

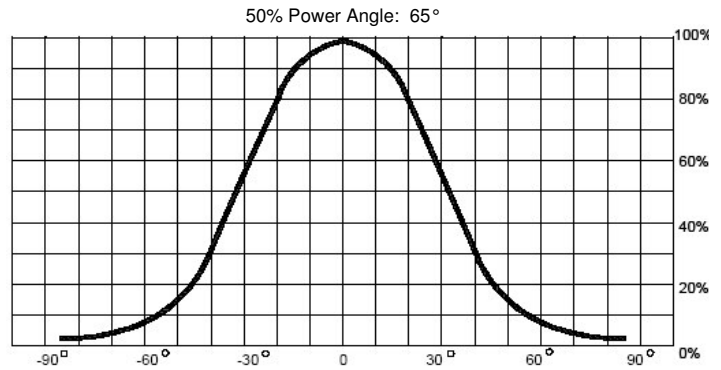

Far Field Pattern

